

**Actuator and Sensor Cable, PUR  
Connection Cable  
WKC4.4T-2/TXL**

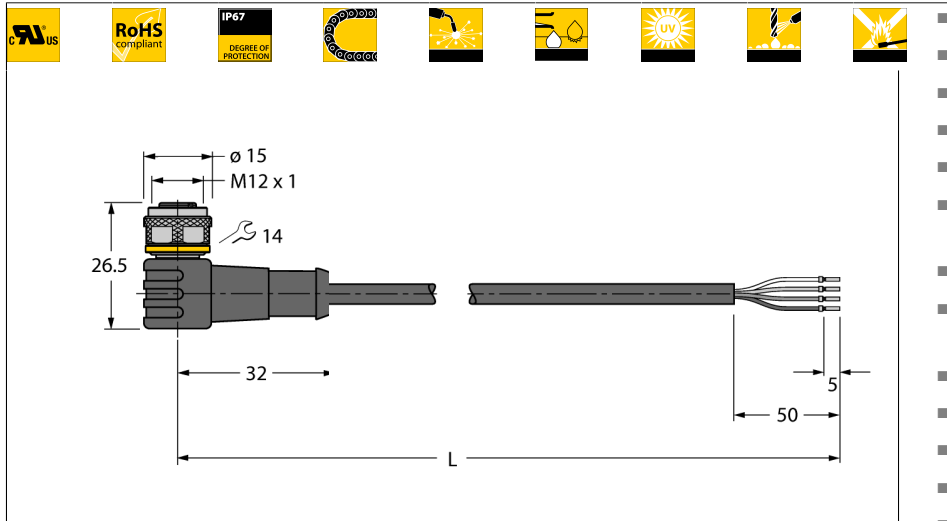

- Female M12, angled, 4-pin
- Sheath material: PUR
- Sheath color: black
- Qualified for drag chain use
- Resistant to weld splatter
- Resistant to chemicals, UV radiation and oils
- Flame retardant
- Free from halogen, silicone, PVC and LABS
- Particularly resistant to abrasion
- Approval: cULus
- RoHS conform
- Protection class IP67
- Cable length: 2.0 m

|                         |               |
|-------------------------|---------------|
| <b>Type designation</b> | WKC4.4T-2/TXL |
| Ident no.               | 6625515       |

**Cable Cross-section**

|                         |   |
|-------------------------|---|
| <b>Connector A side</b> | Female connector, M12x1, Angled                         |
| Number of pins          | 4   |
| Contacts                | Brass, CuZn, Gold-plated                                |
| Contact carriers        | Plastic, TPU, Black                                     |
| Grip                    | Plastic, TPU, Black                                     |
| Coupling nut/screw      | Brass, CuZn, Nickel-plated                              |
| Seal                    | Plastic, FPM/FKM  |
| Protection class        | IP67, A + B side screwed together                       |
| Mechanical lifespan     | > 100 Mating cycles                                     |
| Pollution degree        | 3   |
| Tightening torque       | 0.8 ... 1 Nm<br>(observe max. torque of counter piece!) |

|                        |                        |
|------------------------|------------------------|
| <b>General data</b>    |                        |
| Cable diameter         | 4.7 ± 0.20mm           |
| Cable length           | 2 m                    |
| Cable quality          | PUR                    |
| Cable color            | Black                  |
| Core insulation        | PP                     |
| Core colors            | BN, WH, BU, BK         |
| Core cross-section     | 4x0.34 mm <sup>2</sup> |
| Arrangement of strands | 42x0.1 mm              |

|                                      |              |
|--------------------------------------|--------------|
| <b>Electrical features at +20 °C</b> |              |
| Current                              | 4 A          |
| Rated voltage                        | 250 V        |
| Insulation resistance                | > 30.5 MΩ/km |
| Test voltage                         | 2000 V       |
| Forward resistance                   | max. 57 Ω/km |

|   |                              |
|---|------------------------------|
| <b>Mechanical and chemical properties</b> |                              |
| Bending cycles                            | > 5 mil.                     |
| Bending radius (stationary laying)        | > 5 x Ø                      |
| Bending radius (flexible use)             | > 10 x Ø                     |
| Admissible acceleration                   | max. 5 m/s <sup>2</sup>      |
| Admissible travel path, horizontal        | 5 m (at 5 m/s <sup>2</sup> ) |
| Admissible travel path, vertical          | 2 m (at 5 m/s <sup>2</sup> ) |
| Admissible traversing speed               | 3.3 m/s                      |
| Torsional stress                          | ± 180 °/m                    |
| Ambient temperature                       |                              |
| Stationary                                | -50...+80°C                  |
| In motion                                 | -25...+80°C                  |
| Drag chain operation                      | -25...+60°C                  |

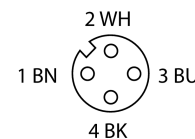
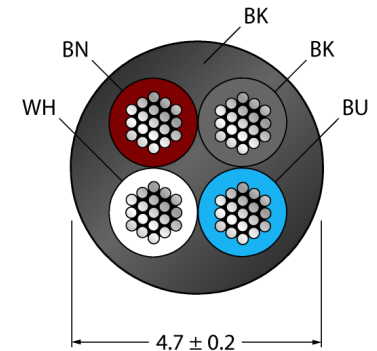

**General information**

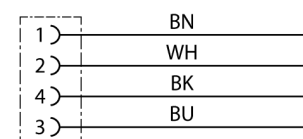

Drawing shows design status including hexagon coupling nut  
(Production start CW11/2016).

**Circuit Diagram**

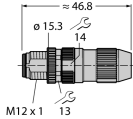
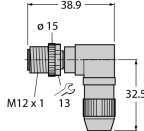
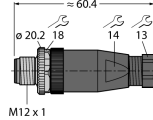
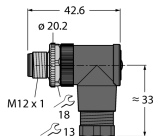

**Actuator and Sensor Cable, PUR  
Connection Cable  
WKC4.4T-2/TXL**

**Accessories**

| Type code            | Ident no. | Description  |   |
|----------------------|-----------|--|---|
| HAS8141-0            | 6905406   | Field-wireable male connector, M12 × 1, straight, 4-pin, insulation piercing connection, cable feedthrough 4.0 to 5.1 mm, core cross-section/terminal capacity 0.14 to 0.34 mm <sup>2</sup> , plastic housing, metal nut |    |
| HAS8241-0            | 6905400   | Field-wireable male connector, M12 × 1, angled, 4-pin, insulation piercing connection, cable feedthrough 4.0 to 5.1 mm, core cross-section/terminal capacity 0.14 to 0.34 mm <sup>2</sup> , plastic housing, metal nut   |    |
| BS8141-0             | 69010     | Field-wireable male connector, M12 × 1, straight, 4-pin, screw terminal connection, cable feedthrough 4.0 to 6.0 mm, core cross-section/terminal capacity 0.14 to 0.75 mm <sup>2</sup> , plastic housing, metal nut      |  |
| BS8241-0             | 69011     | Field-wireable male connector, M12 × 1, angled, 4-pin, screw terminal connection, cable feedthrough 4.0 to 6.0 mm, core cross-section/terminal capacity 0.14 to 0.75 mm <sup>2</sup> , plastic housing, metal nut        |  |
| TORQUE-WRENCH-SET-AS | 6936170   | Torque wrench set; handles with adjustable torque 0.4-1.0 Nm, torque wrench for M8 (SW9), fork wrench for M12 (SW 14)  |  |

**Actuator and Sensor Cable, PUR  
Connection Cable  
WKC4.4T-2/TXL**

**TURCK**

Industrial  
Automation

**Accessories**

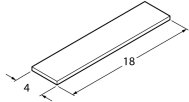
| Type code                         | Ident no. | Description   |   |
|-----------------------------------|-----------|---|---|
| BLANK-LABEL-FOR-CORDESETS-TEL-TXL | 6936206   | Label for TEL and TXL cables, length: 18 mm, height: 4 mm, material: polycarbonate (PC), color: white, halogen-free and flame-retardant |  |